

# Chamber of secrets



## WHAT LIES BEHIND THE WALLS OF TUTANKHAMUN'S TOMB?

Telltale signs of a hidden doorway hint at more rooms beyond the boy king's burial chamber. If so, what lies within? Could it be the tomb of his stepmother Queen Nefertiti that has for so long eluded discovery?

In 1922, Howard Carter peered through a hole into the tomb of Tutankhamun and saw 'wonderful things'. Now Egyptologist Nicholas Reeves believes there may be yet more wonders to discover in the tomb of the 18th Dynasty teenage pharaoh. Examining digital scans of the interior of the young king's burial chamber, he noticed apparent traces of concealed

doorways. Moreover, he believes that behind one of those doors could lie the remains of none other than Queen Nefertiti herself.

The high-resolution images from which Reeves worked were created by the Madrid-based company Factum Arte using state-of-the-art technology to record in detail the tomb's interior, so that a replica tomb being built in a specially designed





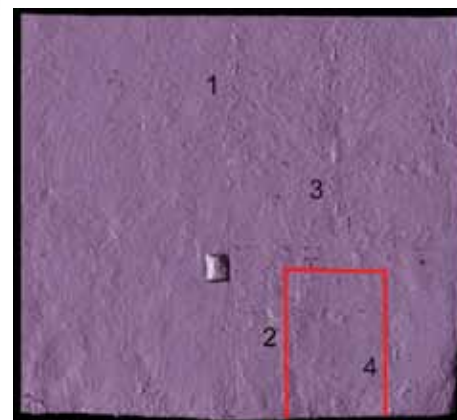

IMAGE: The Theban Mapping Project

ABOVE Scan of the west wall, showing the marks beneath the baboon painting.

LEFT A scene from the first chapter of the Egyptian *Amduat* (*The Book of the Hidden Chamber*), painted on the west wall of the Burial Chamber.

IMAGE: Factum Arte

scene from the first chapter of the Egyptian *Amduat* (*Book of the Hidden Chamber*). The digital scan of the wall taken by Factum Arte reveals several features beneath the decorated surface that suggest the presence of a door to a hidden chamber.

Two parallel lines run vertically up from the floor, reaching to about a third of the height of the wall. Heading down towards them from the ceiling is a natural fault-

line in the rock that disappears a short distance above the point at which the two parallel lines stop. The traces appear to delineate a blocked doorway.

Significantly, Reeves notes that this putative doorway matches the dimensions of the adjacent doorway into the Annexe, which was discovered in 1922 by Howard Carter. We know that the Annexe was cut when the tomb was adapted for Tutankhamun, following his premature death in 1327 BC. The putative new doorway potentially gives access to a room cut at the same time, but completely missed by Carter. >

MAIN IMAGE The entrance to Tutankhamun's tomb in the Valley of the Kings.

building at the entrance to the Valley of the Kings would be indistinguishable from the original. As a result, these images reveal in unprecedented detail every crack, blip, and bump on the wall surfaces.

Reeves, attached to the University of Arizona Egyptian Expedition and a former curator at both the British Museum and the Metropolitan Museum of Art in New York, studied scans of the wall surfaces, and noticed certain marks suggesting the presence of doorways that had been blocked up and painted over in antiquity.

Clearly there may be more to this tomb than immediately meets the eye.

The west wall of the Burial Chamber is decorated with a painting of 12 apes, a

## TUTANKHAMUN (1336-1327 BC)

Tutankhamun succeeded his father, the heretic king Akhenaten, when he was just seven or eight years old. Akhenaten instituted a monotheistic religion based on worship of the sun god Aten, and transferred his capital from Thebes to the newly built town of Amarna (see CWA 63). This break with tradition was hugely unpopular, especially with the priesthood. When Tutankhamun became pharaoh, he returned to the old ways, moved the capital back to Thebes, and reinstated the old gods. He even changed his name from Tutankhaten, meaning 'beloved of Aten', to Tutankhamun, 'beloved of Amun'.

But it was not enough to appease the establishment: after his death, he along with the other kings of the Amarna period, were wiped from the historical records, and omitted from the official kinglist – as inscribed on the Temple of Sety I at Abydos – which jumps from Amenhotep III to Horemheb (who ruled after Tutankhamun's successor Ay).







LEFT The north wall of the Burial Chamber with three painted scenes depicting Tutankhamun – or possibly Nefertiti?

BELOW LEFT Digital scan of the north wall, with Reeves' annotation, which shows features on the surface of the wall.

Another vertical line, labelled 3, runs parallel to it, close to the junction with the east wall, and appears to be a stepped jamb – similar to one that is visible on the lefthand side of the doorway to the Treasury on the east wall. These lines, Reeves reasons, are 'artificially cut and archaeologically significant', defining the limits of an opening that has been blocked up.

The line labelled 2 is particularly significant. This vertical trace corresponds so precisely with the west wall of the Antechamber as to suggest a continuation of it, into the bedrock. If so, it would appear that what is now the Antechamber had begun its life as a long entrance corridor leading northwards beyond what is now Tutankhamun's Burial Chamber. At some point, this corridor was blocked off, with an internal doorway installed to provide longer-term access.

So, how far might the tomb extend beyond Tutankhamun's Burial Chamber, and who might be buried on the other side of this wall?

## The case for a queen

Based on the evidence so far discussed, Reeves believes that Tutankhamun may have been buried in the outer section of a tomb that was already in use – for a member of the royal family. Working on

## Clues on the north wall

On the north wall at the furthest end of the Burial Chamber, Reeves observed more anomalies. This wall is decorated with three scenes depicting Tutankhamun in episodes associated with his translation to the afterlife (see above). Beneath the paintwork, however, Reeves detected signs of a second hidden entrance, visible only on the Factum Arte scans. These high-resolution images reveal the usual, natural fault-lines in the rock. But, again, Reeves spotted other marks that are too regular to be either accidental or naturally occurring.

The first of these marks, labelled 1 on the scan, runs the full height of the chamber and connects to a fault-line that runs diagonally across the ceiling. This line too, he concludes, is almost certainly natural.

However, the remaining two features, labelled 2 and 3 on the scan, look

decidedly man-made. Line no.2 runs vertically from a dog-leg fissure at the top of the wall, down to the floor. The fissure resembles a settlement crack, typical of those often seen following renovation work or in new builds.

RIGHT The plan of the tomb, with Nicholas Reeves' addition showing the alignment of the west wall with a vertical line (2) on the north wall of the Burial Chamber.

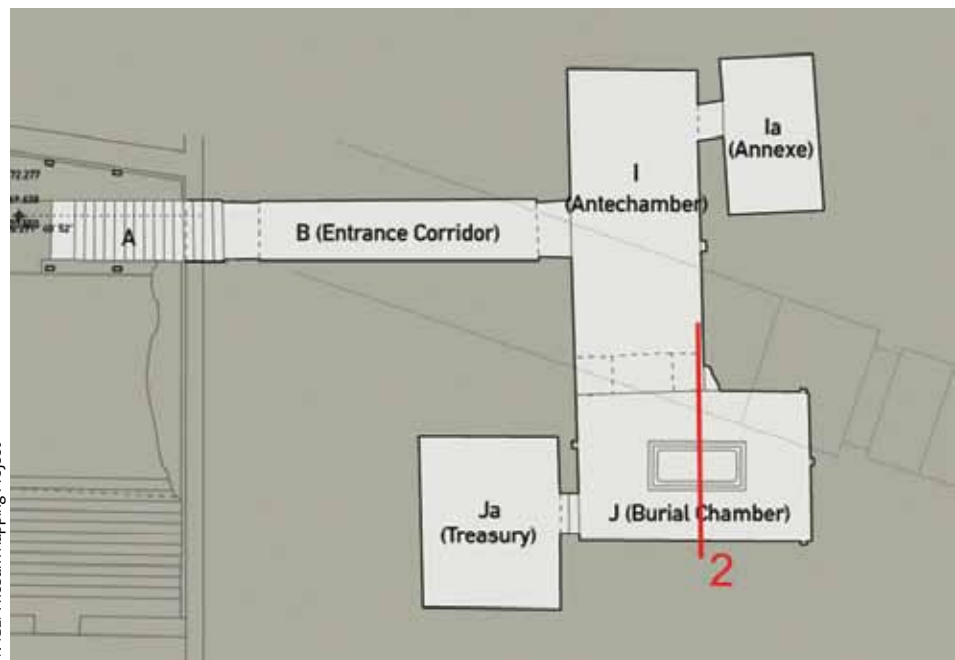

IMAGE: Theban Mapping Project

IMAGE: Factum Arte

the basis that tomb-designs were gender-specific, and that those with a rightward turn to the burial chamber (as this one has) are attributed to queens, this royal burial must be for a queen. His preferred candidate is Queen Nefertiti, wife of Tutankhamun's father Akhenaten, and mother of his young wife Ankhesenamun.

The period following Akhenaten's death is shrouded in mystery, with most of the records that recall his time as ruler and the years immediately following it destroyed by his successors, keen to dissociate themselves from the unpopular heretic king and to condemn him to oblivion. In part because of this *damnatio*, Nefertiti's tomb, though long sought for, has never been identified. There is some debate as to when she died. One theory is that she ended her days in the final years of Akhenaten's reign, and was buried at Amarna, the capital of Egypt during this era.

Reeves, however, believes that Nefertiti in fact survived her husband, ruling first as the co-regent Neferneferuaten, and later, independently, as the full pharaoh Smenkhkare, re-establishing links with the old Amun priesthood and arranging for burial at Thebes. The tomb Nefertiti chose for this burial, Reeves suggests, was a tomb she had begun before Akhenaten's abandonment of Amun's capital for a new site at Amarna. That tomb was KV62 – better known today as the tomb of Tutankhamun. ▶

**BELOW** Layout of Tutankhamun's tomb (KV62) showing the proposed additional chamber (X) behind the west wall, and the extension of the tomb (y) behind the north wall.

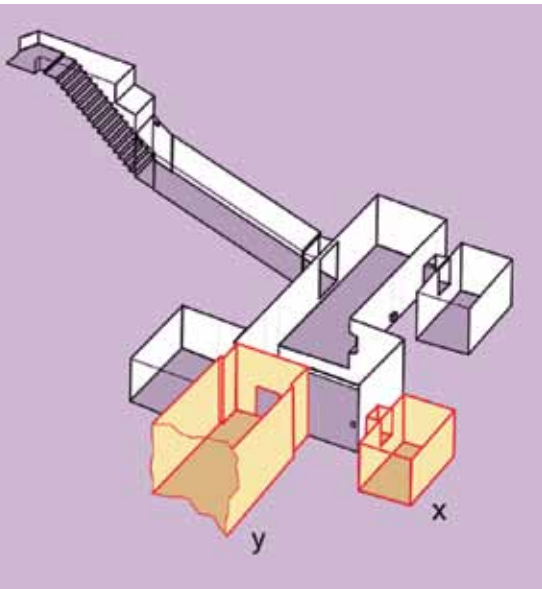

### AMENHOTEP III KV22

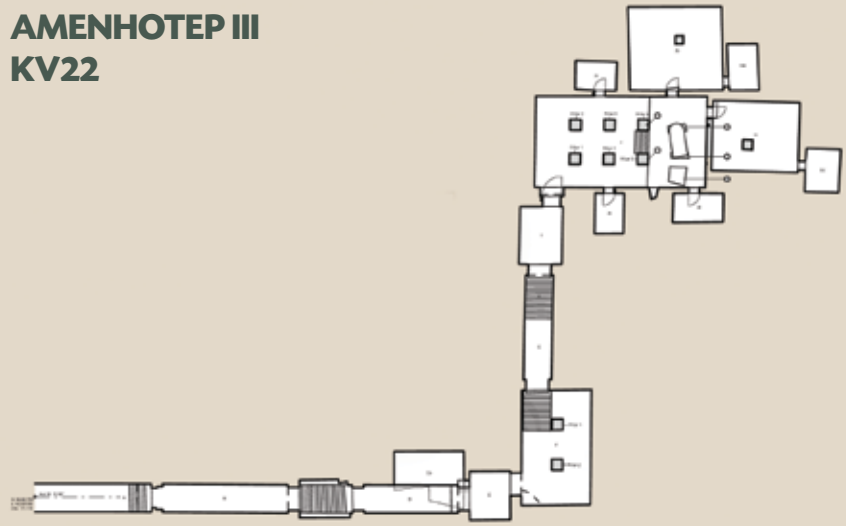

### HOREMHEB KV57

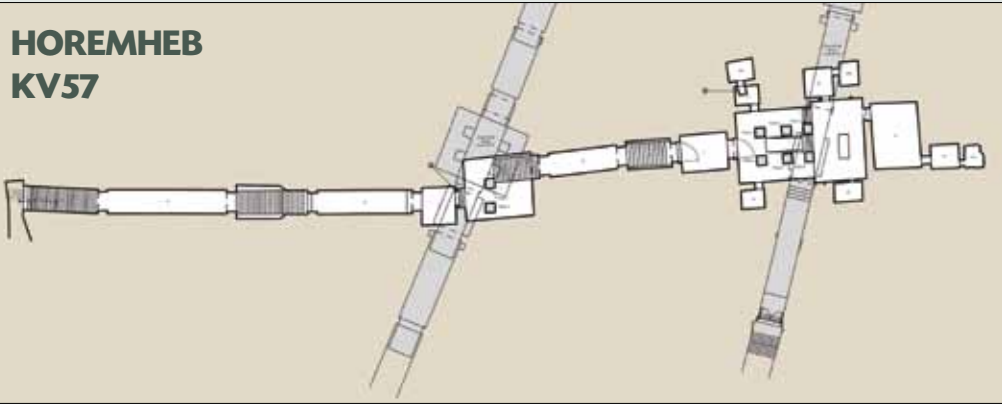

### MERENPTAH KV8

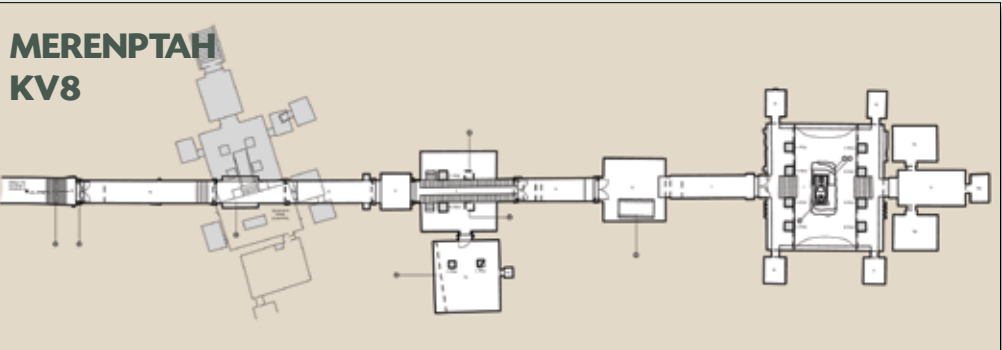

**ABOVE** Tomb design evolved during the 18th and 19th Dynasties from (TOP) the right-angled layout of KV22 (Amenhotep III) shortly before Tutankhamun to (MIDDLE) the kinked design of KV57 (Horemheb) at the end of the 18th Dynasty, and finally (BOTTOM) the linear plan of 19th Dynasty kings such as KV8 (Merenptah).

## DESIGNED FOR KINGS

The Amarna Period, with its new monotheistic religious cult, saw a break in royal funerary traditions. Tomb-building at this point was on the cusp of change from the bent shapes constructed prior to Amarna, to the straight line of everything afterwards. Up until Amenhotep III – father of Akhenaten, and grandfather of Tutankhamun – tombs were designed with a distinct bend. The next completed tomb we know of belongs to Horemheb, the last king of the 18th Dynasty. His tomb is more linear, but with a slight kink, whereas the tombs for kings of the 19th Dynasty onwards were laid out in a straight line.

So where does Tutankhamun's tomb fit within this scenario? Dr Aidan Dodson, of Bristol University: 'This period of the 18th Dynasty was one of atypical tombs. Moreover, classification of a tomb as kingly or queenly based solely on orientation of the entrance corridor to the burial chamber is potentially problematic, especially as so many have been robbed in antiquity, leaving little to identify the deceased. The accepted theory is that Tutankhamun's tomb was probably intended for a member of the nobility but was appropriated and adapted for him in haste, because of his unexpected death at a young age. As such, it is impossible to know how his tomb would have looked had it been designed and built over a long lifetime.'



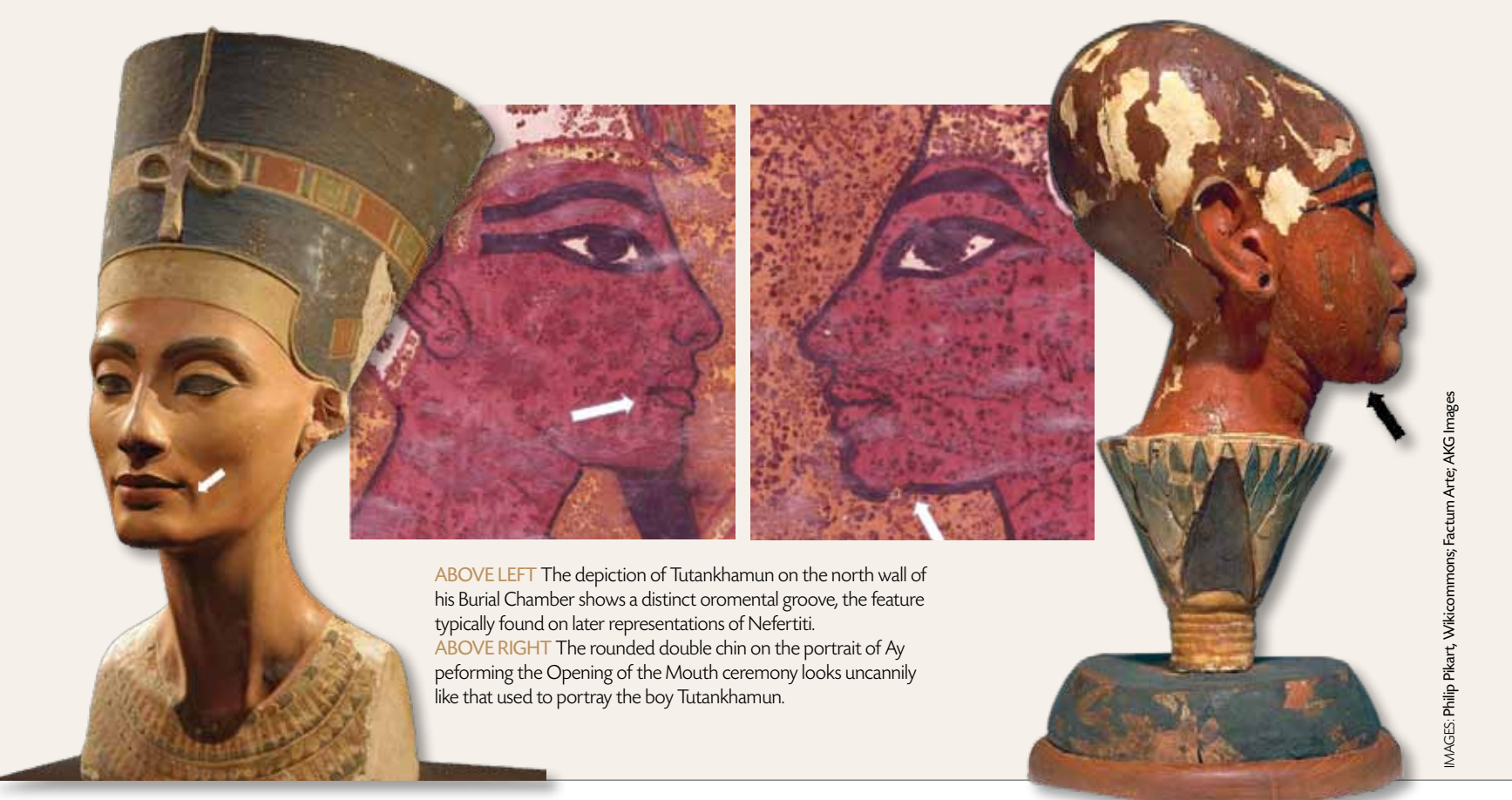

**ABOVE LEFT** The depiction of Tutankhamun on the north wall of his Burial Chamber shows a distinct oromental groove, the feature typically found on later representations of Nefertiti.  
**ABOVE RIGHT** The rounded double chin on the portrait of Ay performing the Opening of the Mouth ceremony looks uncannily like that used to portray the boy Tutankhamun.

IMAGES: Philip Plkart, Wikimedia; Factum Arte; AKG Images

## Behind the image

In 2012, a report by the Getty Conservation Institute revealed that the painting on the north wall of Tutankhamun's Burial Chamber differs from the decoration on the south, east, and west walls of the burial chamber in three significant ways. It displays a different sequence of plaster and paint, and the design is marked out by simple incisions made directly into the plaster, rather than by painted guides as on the other three. Finally,

the scenes on the south, west, and east walls were painted directly onto a yellow background, whereas the scenes on the north wall had been painted onto a white base, with the yellow background we see now applied only subsequently around the pre-existing figures.

Reeves concludes from this that the north wall will have been decorated independently of, and before, the other three, which date to the time of Tutankhamun's interment. He suggests, moreover, that before the chamber was

adapted for the young king's burial, this north wall had stood as a 'blind' – a decorated barrier that both concealed and ritually protected the royal burial behind it. Such constructions are seen in other tombs in the Valley of the Kings, though none are known that have survived intact.

As we have seen, Tutankhamun's proposed 'blind' comprises three scenes, which begin on the far right with a depiction of Tutankhamun's successor Ay performing the ritual Opening of the Mouth on the dead king's mummy; in the middle we see Tutankhamun welcomed into the Underworld by the goddess Nut; and on the left is Tutankhamun and his *ka*, or spirit, being embraced by Osiris, god of the afterlife (see image on p.16).

To identify the painted figures portrayed in these three episodes highlights two specific diagnostic features: namely, a female, concave neck; and a line extending downwards at the corners of the mouth – the so-called 'oromental groove' – both readily observed on later sculptural representations of Nefertiti.

Seemingly clinching the identification, the priest figure, conventionally identified as Tutankhamun's successor Ay, has the distinctive double under-chin not typically seen on other representations of the elderly man, but characteristic of



**LEFT** Factum Arte at work, scanning the east and north walls of Tutankhamun's Burial Chamber.

IMAGE: Factum Arte

## UNTIL WE KNOW FOR SURE, THE POSSIBILITY IS TREMENDOUSLY EXCITING.

images of the young king. This suggests that the priest is in fact the young Tutankhamun, who is known to have officiated at the Opening of the Mouth ceremony of his predecessor Nefertiti.

Tutankhamun's stunning grave goods discovered in 1922 have also revealed evidence associating Nefertiti's burial with that of the boy-king.

We know that much of the treasure found in Tutankhamun's tomb was appropriated from his predecessors, almost certainly because he died before he had time to prepare the requisite material himself – including the famous golden death-mask, which Reeves revealed in 2010 was originally made for Nefertiti and only later reworked to depict Tutankhamun. Reeves estimates that about 80% of the core grave-goods found in the tomb were adapted or recycled from other royal tombs. Many of these grave goods carry the paired cartouches of Ankhkheperure Neferneferuaten, who a number of scholars along with Reeves identify as Nefertiti in her role as co-regent of Akhenaten – before she succeeded him and took on the kingly persona Smenkhkare.

### Exciting projects

If Reeves' interpretations of the Factum Arte images are correct, we must re-evaluate traditional interpretations of KV62 as a small, private tomb that was adapted and enlarged exclusively for Tutankhamun. It would show that he was interred in the outer portion of a larger, pre-existing

burial complex: a corridor-style 'tomb-within-a-tomb' whose main, and most important, burial belongs to a queen who occupied the primary position in the innermost burial chamber, and who enjoyed full pharaonic status. The most probable contender is, of course, Nefertiti,

'Until we know for sure, the possibility is tremendously exciting,' says Dr Christopher Naunton, Director of the Egypt Exploration Society. But questions remain. If there is indeed a third chamber hidden behind the west wall, why, Naunton asks, was it so much better concealed than the other two?

Prof. Norman Hammond, who reported the story in *The Times* told CWA: 'Nick Reeves has an excellent forensic eye. But what is not clear is whether those doorways were ever completed, or whether the marks are of roughing-out of intended doors, never cut because Tutankhamun's sudden death meant the tomb had to be put in service right away.'

Speaking to CWA, Dr Joyce Tyldesley made a similar observation: 'The only plastered and painted walls in Tutankhamun's tomb are the walls of the burial chamber – so if there is a hidden

doorway, it is likely to be in that chamber. But it may well be that what we have here is the ghost outline of unfinished doorways whose construction was halted when the king died.'

The mystery will not be solved until further investigations are carried out inside the tomb itself. Reeves writes: 'Howard Carter lacked the technology to see beneath the tomb's painted walls... he brought his search to a close – wholly unaware that a more significant find by far may have been lying but inches from his grasp.' Today, we have scientific methods such as ground-penetrating radar (GPR) that can prove, without compromising the structure, whether there really are voids on the other side of the north and west walls. As Prof. Hammond says, 'When calm returns to the Valley of the Kings, such non-invasive techniques would be worth trying.'

If the elusive Nefertiti does indeed lie in undisturbed splendour behind Tutankhamun's Burial Chamber, the discovery of her sarcophagus could prove to be one of the most spectacular events in modern archaeology. ■

#### FURTHER INFORMATION

*The Burial of Nefertiti?* by Nicholas Reeves is available online at [www.academia.edu/14406398/The\\_Burial\\_of\\_Nefertiti\\_2015\\_/www.academia.edu/15247276/The\\_Burial\\_of\\_Nefertiti\\_Addenda\\_and\\_Corrigenda\\_2015\\_](http://www.academia.edu/14406398/The_Burial_of_Nefertiti_2015_/www.academia.edu/15247276/The_Burial_of_Nefertiti_Addenda_and_Corrigenda_2015_)

### INTERPRETING A PERIOD OF POLITICAL INTRIGUE

Evidence for the brief period between the death of Akhenaten and the reign of Tutankhamun is capable of multiple interpretations. I have always believed that Nefertiti died during the reign of her husband, Akhenaten, and was buried in the Amarna royal tomb. What happened next is even more speculative. We know that, following his abandonment of Amarna, Tutankhamun emptied out some of the royal tombs, storing their contents in the workshop tomb KV55 in the Valley of the Kings before redistributing them to other tombs in the Valley. It may be that his own eventual tomb, KV62, was another of these Amarna workshop tombs. So, if Nefertiti's body was moved from Amarna to Thebes, there is a possibility that it was stored either temporarily or permanently in Tutankhamun's tomb.

It was typically assumed that this was not Tutankhamun's intended tomb, but that he was buried here, in a private tomb in the Valley of the Kings, by his successor Ay. I would have expected Tutankhamun to select a tomb site in the Western Valley, near that of his respected ancestor Amenhotep III. However, it may be that Ay, who was already an old man and so could not rely on having enough time to build himself a magnificent royal tomb, did a straight swap, for he was eventually buried in the Western Valley near Amenhotep III – possibly in a tomb built by Tutankhamun.

Dr Joyce Tyldesley, University of Manchester



ABOVE Howard Carter and his assistant open the sarcophagus.